

PROVEDENÍ 0F

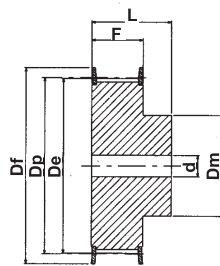

PROVEDENÍ 1F

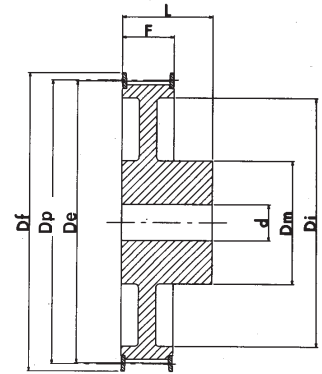

PROVEDENÍ 2F

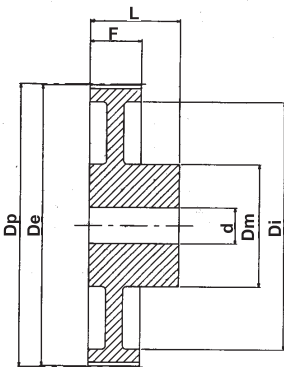

PROVEDENÍ 3

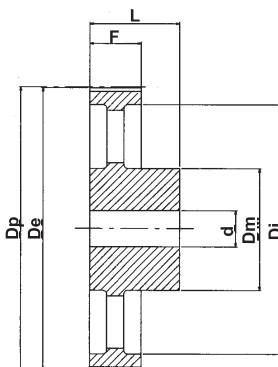

PROVEDENÍ 4

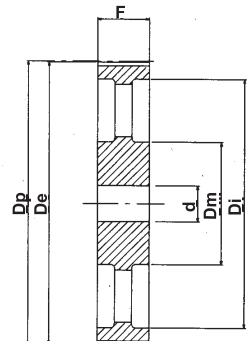

PROVEDENÍ 5

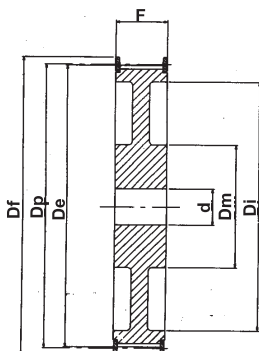

PROVEDENÍ 6F

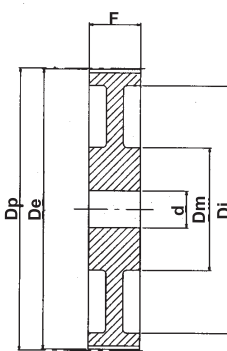

PROVEDENÍ 7

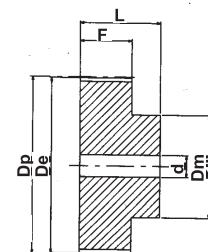

PROVEDENÍ 8

Ozubené řemenice

typ HTD, metrická rozteč, předvrtané provedení,
materiál hliník/ocel/šedá litina

HTD 3M pro řemen š - 9 mm

Objednací číslo	Počet zubů	Typ	D _P	D _e	D _f	D _m	F	L	Vrtání d*	Příruba číslo	Materiál	
10-3M-09	10	0F	9,55	8,79	13,0	13,0	10,2	17,5		501	hliník	s přírubou
12-3M-09	12	0F	11,46	10,70	15,0	15,0	10,2	17,5		502	hliník	
14-3M-09	14	0F	13,37	12,61	16,0	16,0	10,2	17,5		503	hliník	
15-3M-09	15	0F	14,32	13,56	17,5	17,5	10,2	17,5		516	hliník	
16-3M-09	16	1F	15,28	14,52	17,5	10,0	12,8	20,6	4,0	504	hliník	
18-3M-09	18	1F	17,19	16,43	20,0	11,0	12,8	20,6	6,0	505	hliník	
20-3M-09	20	1F	19,10	18,34	23,0	13,0	12,8	20,6	6,0	517	hliník	
21-3M-09	21	1F	20,05	19,29	25,0	14,0	12,8	20,6	6,0	518	hliník	
22-3M-09	22	1F	21,01	20,25	25,0	14,0	12,8	20,6	6,0	518	hliník	
24-3M-09	24	1F	22,92	22,16	25,0	14,0	12,8	20,6	6,0	518	hliník	
26-3M-09	26	1F	24,83	24,07	28,0	16,0	12,8	20,6	6,0	508	hliník	
28-3M-09	28	1F	26,74	25,98	32,0	18,0	12,8	20,6	6,0	509	hliník	
30-3M-09	30	1F	28,65	27,89	32,0	20,0	12,8	20,6	6,0	509	hliník	
32-3M-09	32	1F	30,56	29,80	36,0	22,0	12,8	20,6	6,0	510	hliník	
36-3M-09	36	1F	34,38	33,62	39,0	26,0	13,4	22,2	6,0	519	hliník	
40-3M-09	40	1F	38,20	37,44	42,0	28,0	13,4	22,2	6,0	513	hliník	
44-3M-09	44	1F	42,02	41,26	48,0	33,0	13,4	22,2	6,0	520	hliník	
48-3M-09	48	8	45,84	45,08		33,0	13,4	22,2	8,0		hliník	bez příruby
60-3M-09	60	8	57,30	56,54		33,0	13,4	22,2	8,0		hliník	
72-3M-09	72	8	68,75	67,99		33,0	13,4	22,2	8,0		hliník	

HTD 3M pro řemen š - 15 mm

Objednací číslo	Počet zubů	Typ	D _P	D _e	D _f	D _m	F	L	Vrtání d*	Příruba číslo	Materiál	
10-3M-15	10	0F	9,55	8,79	13,0	13,0	17,0	26,0		501	hliník	s přírubou
12-3M-15	12	0F	11,46	10,70	15,0	15,0	17,0	26,0		502	hliník	
14-3M-15	14	0F	13,37	12,61	16,0	16,0	17,0	26,0		503	hliník	
15-3M-15	15	0F	14,32	13,56	17,5	17,5	17,0	26,0		516	hliník	
16-3M-15	16	1F	15,28	14,52	17,5	10,0	19,5	26,0	4,0	504	hliník	
18-3M-15	18	1F	17,19	16,43	20,0	11,0	19,5	26,0	6,0	505	hliník	
20-3M-15	20	1F	19,10	18,34	23,0	13,0	19,5	26,0	6,0	517	hliník	
21-3M-15	21	1F	20,05	19,29	25,0	14,0	19,5	26,0	6,0	518	hliník	
22-3M-15	22	1F	21,01	20,25	25,0	14,0	19,5	26,0	6,0	518	hliník	
24-3M-15	24	1F	22,92	22,16	25,0	14,0	19,5	26,0	6,0	518	hliník	
26-3M-15	26	1F	24,83	24,07	28,0	16,0	19,5	26,0	6,0	508	hliník	
28-3M-15	28	1F	26,74	25,98	32,0	18,0	19,5	26,0	6,0	509	hliník	
30-3M-15	30	1F	28,65	27,89	32,0	20,0	19,5	26,0	6,0	509	hliník	
32-3M-15	32	1F	30,56	29,80	36,0	22,0	19,5	26,0	6,0	510	hliník	
36-3M-15	36	1F	34,38	33,62	39,0	26,0	20,0	30,0	6,0	519	hliník	
40-3M-15	40	1F	38,20	37,44	42,0	28,0	20,0	30,0	6,0	513	hliník	
44-3M-15	44	1F	42,02	41,26	48,0	33,0	20,0	30,0	6,0	520	hliník	
48-3M-15	48	8	45,84	45,08		33,0	20,0	30,0	8,0		hliník	bez příruby
60-3M-15	60	8	57,30	56,54		33,0	20,0	30,0	8,0		hliník	
72-3M-15	72	8	68,75	67,99		33,0	20,0	30,0	8,0		hliník	

* Hodnoty se mohou lišit.

HTD 5M pro řemen š - 9 mm

Objednací číslo	Počet zubů	Typ	D _P	D _e	D _f	D _m	D _i	F	L	Vrtání d*	Příruba číslo	Materiál	
12-5M-09	12	1F	19,10	17,96	23	13,0		14,5	20,0	4,0	14	ocel	s přírubou
14-5M-09	14	1F	22,28	21,14	25	13,0		14,5	20,0	6,0	2	ocel	
15-5M-09	15	1F	23,87	22,73	28	16,0		14,5	20,0	6,0	4	ocel	
16-5M-09	16	1F	25,46	24,32	28	16,5		14,5	20,0	6,0	4	ocel	
18-5M-09	18	1F	28,65	27,51	32	20,0		14,5	20,0	6,0	6	ocel	
20-5M-09	20	1F	31,83	30,69	36	23,0		14,5	22,5	6,0	8	ocel	
21-5M-09	21	1F	33,42	32,28	38	24,0		14,5	22,5	6,0	9	ocel	
22-5M-09	22	1F	35,01	33,87	39	25,5		14,5	22,5	6,0	15	ocel	
24-5M-09	24	1F	38,20	37,06	42	27,0		14,5	22,5	6,0	13	ocel	
26-5M-09	26	1F	41,38	40,24	44	30,0		14,5	22,5	6,0	12	ocel	
28-5M-09	28	1F	44,56	43,42	48	30,5		14,5	22,5	6,0	11	ocel	
30-5M-09	30	1F	47,75	46,60	51	35,0		14,5	22,5	6,0	16	ocel	
32-5M-09	32	1F	50,93	49,79	54	38,0		14,5	22,5	8,0	18	ocel	
36-5M-09	36	1F	57,30	56,16	60	38,0		14,5	22,5	8,0	21	ocel	
40-5M-09	40	1F	63,66	62,52	71	38,0		14,5	22,5	8,0	25	ocel	
44-5M-09	44	3	70,03	68,89		38,0	54	14,5	25,5	8,0		hliník	bez příruby
48-5M-09	48	3	76,39	75,25		45,0	61	14,5	25,5	8,0		hliník	
60-5M-09	60	3	95,49	94,35		45,0	80	14,5	25,5	8,0		hliník	
72-5M-09	72	3	114,59	113,45		45,0	100	14,5	25,5	8,0		hliník	

HTD 5M pro řemen š - 15 mm

Objednací číslo	Počet zubů	Typ	D _P	D _e	D _f	D _m	D _i	F	L	Vrtání d*	Příruba číslo	Materiál	
12-5M-15	12	1F	19,10	17,96	23	13,0		20,5	26,0		14	ocel	s přírubou
14-5M-15	14	1F	22,28	21,14	25	13,0		20,5	26,0	6,0	2	ocel	
15-5M-15	15	1F	23,87	22,73	28	16,0		20,5	26,0	6,0	4	ocel	
16-5M-15	16	1F	25,46	24,32	28	16,5		20,5	26,0	6,0	4	ocel	
18-5M-15	18	1F	28,65	27,51	32	20,0		20,5	26,0	6,0	6	ocel	
20-5M-15	20	1F	31,83	30,69	36	23,0		20,5	26,0	6,0	8	ocel	
21-5M-15	21	1F	33,42	32,28	38	24,0		20,5	26,0	6,0	9	ocel	
22-5M-15	22	1F	35,01	33,87	39	25,5		20,5	26,0	6,0	15	ocel	
24-5M-15	24	1F	38,20	37,06	42	27,0		20,5	28,0	6,0	13	ocel	
26-5M-15	26	1F	41,38	40,24	44	30,0		20,5	28,0	6,0	12	ocel	
28-5M-15	28	1F	44,56	43,42	48	30,5		20,5	28,0	6,0	11	ocel	
30-5M-15	30	1F	47,75	46,60	51	35,0		20,5	28,0	6,0	16	ocel	
32-5M-15	32	1F	50,93	49,79	54	38,0		20,5	28,0	8,0	18	ocel	
36-5M-15	36	1F	57,30	56,16	60	38,0		20,5	28,0	8,0	21	ocel	
40-5M-15	40	1F	63,66	62,52	71	38,0		20,5	28,0	8,0	25	ocel	
44-5M-15	44	3	70,03	68,89		38,0	54	20,5	30,0	8,0		hliník	bez příruby
48-5M-15	48	3	76,39	75,25		38,0	61	20,5	30,0	8,0		hliník	
60-5M-15	60	3	95,49	94,35		50,0	80	20,5	30,0	8,0		hliník	
72-5M-15	72	3	114,59	113,45		50,0	100	20,5	30,0	8,0		hliník	

* Hodnoty se mohou lišit.

Ozubené řemenice

typ HTD, metrická rozteč, předvrtané provedení,
materiál hliník/ocel/šedá litina



HTD 5M pro řemen š - 25 mm

Objednací číslo	Počet zubů	typ	D _P	D _e	D _f	D _m	D _i	F	L	Vrtání d ^{**}	Příruba číslo	Materiál	
12-5M-25	12	1F	19,10	17,96	23	13,0		30,5	36,0		14	ocel	s přírubou
14-5M-25	14	1F	22,28	21,14	25	13,0		30,5	36,0	6,0	2	ocel	
15-5M-25	15	1F	23,87	22,73	28	16,0		30,5	36,0	6,0	4	ocel	
16-5M-25	16	1F	25,46	24,32	28	16,5		30,5	36,0	6,0	4	ocel	
18-5M-25	18	1F	28,65	27,51	32	20,0		30,5	36,0	6,0	6	ocel	
20-5M-25	20	1F	31,83	30,69	36	23,0		30,5	36,0	6,0	8	ocel	
21-5M-25	21	1F	33,42	32,28	38	24,0		30,5	38,0	6,0	9	ocel	
22-5M-25	22	1F	35,01	33,87	39	25,5		30,5	38,0	6,0	15	ocel	
24-5M-25	24	1F	38,20	37,06	42	27,0		30,5	38,0	6,0	13	ocel	
26-5M-25	26	1F	41,38	40,24	44	30,0		30,5	38,0	6,0	12	ocel	
28-5M-25	28	1F	44,56	43,42	48	30,5		30,5	38,0	6,0	11	ocel	
30-5M-25	30	1F	47,75	46,60	51	35,0		30,5	38,0	6,0	16	ocel	
32-5M-25	32	1F	50,93	49,79	54	38,0		30,5	38,0	8,0	18	ocel	
36-5M-25	36	1F	57,30	56,16	60	38,0		30,5	38,0	8,0	21	ocel	
40-5M-25	40	1F	63,66	62,52	71	38,0		30,5	38,0	8,0	25	ocel	
44-5M-25	44	8	70,03	68,89		38,0		30,5	40,0	8,0		hliník	bez příruby
48-5M-25	48	3	76,39	75,25		38,0	61	30,5	40,0	8,0		hliník	
60-5M-25	60	3	95,49	94,35		50,0	80	30,5	40,0	8,0		hliník	
72-5M-25	72	3	114,59	113,45		50,0	100	30,5	40,0	8,0		hliník	

HTD 8M pro řemen š - 20 mm

Objednací číslo	Počet zubů	typ	D _P	D _e	D _f	D _m	D _i	F	L	Vrtání d ^{**}	Příruba číslo	Materiál	
22-8M-20	22	1F	56,02	54,65	60	43		28	38	12	53	ocel	s přírubou
24-8M-20	24	1F	61,12	59,75	66	45		28	38	12	69	ocel	
26-8M-20	26	1F	66,21	64,85	70	48		28	38	12	61	ocel	
28-8M-20	28	1F	71,30	70,08	75	50		28	38	15	79	ocel	
30-8M-20	30	1F	76,39	75,13	83	55		28	38	15	73	ocel	
32-8M-20	32	1F	81,49	80,16	87	60		28	38	15	76	ocel	
34-8M-20	34	1F	86,58	85,22	91	66		28	38	15	66	ocel	
36-8M-20	36	1F	91,67	90,30	97	70		28	38	15	68	ocel	
38-8M-20	38	1F	96,77	95,39	102	75		28	38	15	70	ocel	
40-8M-20	40	1F	101,86	100,49	106	75		28	38	15	77	ocel	
44-8M-20	44	1F	112,05	110,67	120	75		28	38	15	75	ocel	
48-8M-20	48	1F	122,23	120,86	128	75		28	38	15	78	ocel	
56-8M-20	56	2F	142,60	141,23	150	80	116	28	38	15	85	ocel	
64-8M-20	64	2F	162,97	161,60	168	80	137	28	38	15	90	ocel	
72-8M-20	72	2F	183,35	181,97	192	80	158	28	38	15	97	ocel	
80-8M-20	80	3	203,72	202,35		90	180	28	38	15		litina	bez příruby
90-8M-20	90	3	229,18	227,81		90	204	28	38	15		litina	
*112-8M-20	112	4	285,21	283,83		90	254	28	38	18		litina	
*144-8M-20	144	4	366,69	365,32		90	336	28	38	20		litina	
*168-8M-20	168	4	427,81	426,44		100	400	28	38	20		litina	
*192-8M-20	192	4	488,92	487,55		100	460	28	38	20		litina	

* Na poptávku

**Hodnoty se mohou lišit.

HTD 8M pro řemen š - 30 mm

Objednací číslo	Počet zubů	Typ	D _P	D _e	D _f	D _m	D _i	F	L	Vrtání d*	Příruba číslo	Materiál	
22-8M-30	22	1F	56,02	54,65	60	43		38	48	12	53	ocel	s přírubou
24-8M-30	24	1F	61,12	59,75	66	45		38	48	12	69	ocel	
26-8M-30	26	1F	66,21	64,85	70	48		38	48	12	61	ocel	
28-8M-30	28	1F	71,30	70,08	75	50		38	48	15	79	ocel	
30-8M-30	30	1F	76,39	75,13	83	55		38	48	15	73	ocel	
32-8M-30	32	1F	81,49	80,16	87	60		38	48	15	76	ocel	
34-8M-30	34	1F	86,58	85,22	91	66		38	48	15	66	ocel	
36-8M-30	36	1F	91,67	90,30	97	70		38	48	15	68	ocel	
38-8M-30	38	1F	96,77	95,39	102	75		38	48	15	70	ocel	
40-8M-30	40	1F	101,86	100,49	106	75		38	48	15	77	ocel	
44-8M-30	44	1F	112,05	110,67	120	75		38	48	15	75	ocel	
48-8M-30	48	1F	122,23	120,86	128	75		38	48	15	78	ocel	
56-8M-30	56	2F	142,60	141,23	150	90	116	38	48	15	85	ocel	
64-8M-30	64	2F	162,97	161,60	168	90	137	38	48	15	90	ocel	
72-8M-30	72	2F	183,35	181,97	192	95	158	38	48	15	97	ocel	
80-8M-30	80	3	203,72	202,35		100	180	38	48	15		litina	bez příruby
90-8M-30	90	3	229,18	227,81		100	204	38	48	15		litina	
112-8M-30	112	4	285,21	283,83		100	254	38	48	18		litina	
144-8M-30	144	4	366,69	365,32		100	336	38	48	20		litina	
168-8M-30	168	4	427,81	426,44		100	400	38	48	20		litina	
192-8M-30	192	4	488,92	487,55		100	460	38	48	20		litina	

HTD 8M pro řemen š - 50 mm

Objednací číslo	Počet zubů	Typ	D _P	D _e	D _f	D _m	D _i	F	L	Vrtání d*	Příruba číslo	Materiál	
22-8M-50	22	1F	56,02	54,65	60	43		60	70		53	ocel	s přírubou
24-8M-50	24	1F	61,12	59,75	66	45		60	70		69	ocel	
26-8M-50	26	1F	66,21	64,85	70	48		60	70		61	ocel	
28-8M-50	28	1F	71,30	70,08	75	50		60	70		79	ocel	
30-8M-50	30	1F	76,39	75,13	83	55		60	70		73	ocel	
32-8M-50	32	1F	81,49	80,16	87	60		60	70		76	ocel	
34-8M-50	34	1F	86,58	85,22	91	66		60	70		66	ocel	
36-8M-50	36	1F	91,67	90,30	97	70		60	70		68	ocel	
38-8M-50	38	1F	96,77	95,39	102	75		60	70		70	ocel	
40-8M-50	40	1F	101,86	100,49	106	75		60	70		77	ocel	
44-8M-50	44	1F	112,05	110,67	120	75		60	70		75	ocel	
48-8M-50	48	1F	122,23	120,86	128	80		60	70		78	ocel	
56-8M-50	56	6F	142,60	141,23	150	90	116	60	60	18	85	ocel	
64-8M-50	64	6F	162,97	161,60	168	100	137	60	60	18	90	ocel	
72-8M-50	72	6F	183,35	181,97	192	100	158	60	60	18	97	ocel	
80-8M-50	80	7	203,72	202,35		110	180	60	60	18		litina	bez příruby
90-8M-50	90	7	229,18	227,81		110	204	60	60	18		litina	
112-8M-50	112	5	285,21	283,83		110	254	60	60	18		litina	
144-8M-50	144	5	366,69	365,32		110	336	60	60	20		litina	
168-8M-50	168	5	427,81	426,44		120	400	60	60	20		litina	
192-8M-50	192	5	488,92	487,55		130	460	60	60	20		litina	

* Hodnoty se mohou lišit.

Ozubené řemenice

typ HTD, metrická rozteč, předvrtané provedení,
materiál hliník/ocel/šedá litina

HTD 8M pro řemen š - 85 mm

Objednáací číslo	Počet zubů	Typ	D _P	D _e	D _f	D _m	D _i	F	L	Vrtání d ^{**}	Příruba číslo	Materiál	
22-8M-85	22	1F	56,02	54,65	60	43		95	105		53	ocel	s přírubou
24-8M-85	24	1F	61,12	59,75	66	45		95	105		69	ocel	
26-8M-85	26	1F	66,21	64,85	70	48		95	105		61	ocel	
28-8M-85	28	1F	71,30	70,08	75	50		95	105		79	ocel	
30-8M-85	30	1F	76,39	75,13	83	55		95	105		73	ocel	
32-8M-85	32	1F	81,49	80,16	87	60		95	105		76	ocel	
34-8M-85	34	1F	86,58	85,22	91	66		95	105		66	ocel	
36-8M-85	36	1F	91,67	90,30	97	70		95	105		68	ocel	
38-8M-85	38	1F	96,77	95,39	102	75		95	105		70	ocel	
40-8M-85	40	1F	101,86	100,49	106	75		95	105		77	ocel	
44-8M-85	44	1F	112,05	110,67	120	75		95	105		75	ocel	
48-8M-85	48	1F	122,23	120,86	128	80		95	105		78	ocel	
56-8M-85	56	1F	142,60	141,23	150	90		95	105	20	85	ocel	
64-8M-85	64	6F	162,97	161,60	168	100	137	95	95	20	90	ocel	
72-8M-85	72	6F	183,35	181,97	192	100	158	95	95	20	97	ocel	
80-8M-85	80	5	203,72	202,35		110	180	95	95	20		litina	bez příruby
90-8M-85	90	5	229,18	227,81		110	204	95	95	20		litina	
112-8M-85	112	5	285,21	283,83		110	254	95	95	24		litina	
144-8M-85	144	5	366,69	365,32		110	336	95	95	24		litina	
*168-8M-85	168	5	427,81	426,44		120	400	95	95	24		litina	
*192-8M-85	192	5	488,92	487,55		130	460	95	95	24		litina	

HTD 14M pro řemen š - 40 mm

Objednáací číslo	Počet zubů	Typ	D _P	D _e	D _f	D _m	D _i	F	L	Vrtání d ^{**}	Příruba číslo	Materiál	
28-14M-40	28	1F	124,78	122,12	128	100		54	69	24	153	ocel	s přírubou
*29-14M-40	29	1F	129,23	126,57	138	100		54	69	24	154	ocel	
30-14M-40	30	1F	133,69	130,99	138	100		54	69	24	154	ocel	
32-14M-40	32	1F	142,60	139,88	154	100		54	69	24	160	ocel	
34-14M-40	34	1F	151,52	148,79	160	100		54	69	24	166	ocel	
36-14M-40	36	1F	160,43	157,68	168	100		54	69	24	168	ocel	
38-14M-40	38	1F	169,34	166,60	183	120		54	69	24	172	ocel	
40-14M-40	40	1F	178,25	175,49	188	120		54	69	24	162	ocel	
44-14M-40	44	1F	196,08	193,28	211	120		54	69	24	175	ocel	
48-14M-40	48	2F	213,90	211,11	226	135	170	54	69	24	180	litina	
56-14M-40	56	2F	249,55	246,76	256	135	207	54	69	28	182	litina	
64-14M-40	64	2F	285,21	282,41	296	135	240	54	69	28	184	litina	
72-14M-40	72	4	320,86	318,06		135	278	54	69	28		litina	
80-14M-40	80	4	356,51	353,71		135	314	54	69	28		litina	
90-14M-40	90	4	401,07	398,28		135	358	54	69	28		litina	
112-14M-40	112	4	499,11	496,32		135	456	54	69	28		litina	
*144-14M-40	144	4	641,71	638,92		135	600	54	69	28		litina	
*168-14M-40	168	4	748,66	745,87		135	706	54	69	28		litina	
*192-14M-40	192	4	855,62	852,82		135	813	54	69	28		litina	
*216-14M-40	216	4	962,57	959,76		150	920	54	69	28		litina	

* Na poptávku

**Hodnoty se mohou lišit.

HTD 14M pro řemen š - 55 mm

Objednací číslo	Počet zubů	Typ	D _p	D _e	D _f	D _m	D _i	F	L	Vrtání d ^{**}	Příruba číslo	Materiál	
28-14M-55	28	1F	124,78	122,12	128	100		70	85	24	153	ocel	s přírubou
*29-14M-55	29	1F	129,23	126,57	138	100		70	85	24	154	ocel	
30-14M-55	30	1F	133,69	130,99	138	100		70	85	24	154	ocel	
32-14M-55	32	1F	142,60	139,88	154	100		70	85	24	160	ocel	
34-14M-55	34	1F	151,52	148,79	160	100		70	85	24	166	ocel	
36-14M-55	36	1F	160,43	157,68	168	100		70	85	24	168	ocel	
38-14M-55	38	1F	169,34	166,60	183	120		70	85	24	172	ocel	
40-14M-55	40	1F	178,25	175,49	188	120		70	85	24	162	ocel	
44-14M-55	44	1F	196,08	193,28	211	120		70	85	24	175	ocel	
48-14M-55	48	6F	213,90	211,11	226	135	170	70	70	24	180	litina	
56-14M-55	56	6F	249,55	246,76	256	135	207	70	70	28	182	litina	
64-14M-55	64	6F	285,21	282,41	296	135	240	70	70	28	184	litina	
72-14M-55	72	5	320,86	318,06		135	278	70	70	28		litina	bez příruby
80-14M-55	80	5	356,51	353,71		135	314	70	70	28		litina	
90-14M-55	90	5	401,07	398,28		135	358	70	70	28		litina	
112-14M-55	112	5	499,11	496,32		135	456	70	70	28		litina	
144-14M-55	144	5	641,71	638,92		135	600	70	70	28		litina	
168-14M-55	168	5	748,66	745,87		135	706	70	70	28		litina	
192-14M-55	192	5	855,62	852,82		135	813	70	70	28		litina	
*216-14M-55	216	5	962,57	959,76		150	920	70	70	28		litina	

HTD 14M pro řemen š - 85 mm

Objednací číslo	Počet zubů	Typ	D _p	D _e	D _f	D _m	D _i	F	L	Vrtání d ^{**}	Příruba číslo	Materiál	
28-14M-85	28	1F	124,78	122,12	128	100		102	117		153	ocel	s přírubou
*29-14M-85	29	1F	129,23	126,57	138	100		102	117		154	ocel	
30-14M-85	30	1F	133,69	130,99	138	100		102	117		154	ocel	
32-14M-85	32	1F	142,60	139,88	154	100		102	117		160	ocel	
34-14M-85	34	1F	151,52	148,79	160	100		102	117		166	ocel	
36-14M-85	36	1F	160,43	157,68	168	100		102	117		168	ocel	
38-14M-85	38	1F	169,34	166,60	183	120		102	117		172	ocel	
40-14M-85	40	1F	178,25	175,49	188	135		102	117		162	ocel	
44-14M-85	44	1F	196,08	193,28	211	135		102	117		175	ocel	
48-14M-85	48	1F	213,90	211,11	226	150		102	117		180	ocel	
56-14M-85	56	6F	249,55	246,76	256	150	207	102	102	32	182	litina	
64-14M-85	64	6F	285,21	282,41	296	150	240	102	102	32	184	litina	
72-14M-85	72	5	320,86	318,06		150	278	102	102	32		litina	bez příruby
80-14M-85	80	5	356,51	353,71		150	314	102	102	32		litina	
90-14M-85	90	5	401,07	398,28		150	358	102	102	32		litina	
112-14M-85	112	5	499,11	496,32		150	456	102	102	32		litina	
144-14M-85	144	5	641,71	638,92		150	600	102	102	32		litina	
168-14M-85	168	5	748,66	745,87		150	706	102	102	32		litina	
192-14M-85	192	5	855,62	852,82		165	813	102	102	32		litina	
*216-14M-85	216	5	962,57	959,76		165	920	102	102	32		litina	

* Na požádání

**Hodnoty se mohou lišit.

Ozubené řemenice

typ HTD, metrická rozteč, předvrtané provedení,
materiál hliník/ocel/šedá litina

HTD 14M pro řemen š - 115 mm

Objednací číslo	Počet zubů	Typ	D _P	D _e	D _f	D _m	D _i	F	L	Vrtání d**	Příruba číslo	Materiál	
28-14M-115	28	1F	124,78	122,12	128	100		133	148		153	ocel	s přírubou
*29-14M-115	29	1F	129,23	126,57	138	100		133	148		154	ocel	
30-14M-115	30	1F	133,69	130,99	138	100		133	148		154	ocel	
32-14M-115	32	1F	142,60	139,88	154	100		133	148		160	ocel	
34-14M-115	34	1F	151,52	148,79	160	100		133	148		166	ocel	
36-14M-115	36	1F	160,43	157,68	168	120		133	148		168	ocel	
38-14M-115	38	1F	169,34	166,60	183	120		133	148		172	ocel	
40-14M-115	40	1F	178,25	175,49	188	135		133	148		162	ocel	
44-14M-115	44	1F	196,08	193,28	211	140		133	148		175	ocel	
48-14M-115	48	1F	231,90	211,11	226	150		133	148		180	ocel	
56-14M-115	56	1F	249,55	246,76	256	150		133	148		182	ocel	
64-14M-115	64	6F	285,21	282,41	296	150	240	133	133	32	184	litina	
72-14M-115	72	5	320,86	318,06		150	278	133	133	32		litina	
80-14M-115	80	5	356,51	353,71		150	314	133	133	32		litina	
90-14M-115	90	5	401,07	398,28		150	358	133	133	32		litina	
112-14M-115	112	5	499,11	496,32		150	456	133	133	32		litina	
144-14M-115	144	5	641,71	638,92		165	600	133	133	32		litina	
168-14M-115	168	5	748,66	745,87		165	706	133	133	32		litina	
192-14M-115	192	5	855,62	852,82		165	813	133	133	32		litina	
*216-14M-115	216	5	962,57	959,76		165	920	133	133	32		litina	

HTD 14M pro řemen š - 170mm

Objednací číslo	Počet zubů	Typ	D _P	D _e	D _f	D _m	D _i	F	L	Vrtání d**	Příruba číslo	Materiál	
28-14M-170	28	1F	124,78	122,12	128	100		187	202		153	ocel	s přírubou
*29-14M-170	29	1F	129,23	126,57	138	100		187	202		154	ocel	
30-14M-170	30	1F	133,69	130,99	138	100		187	202		154	ocel	
32-14M-170	32	1F	142,60	139,88	154	100		187	202		160	ocel	
34-14M-170	34	1F	151,52	148,79	160	100		187	202		166	ocel	
36-14M-170	36	1F	160,43	157,68	168	120		187	202		168	ocel	
38-14M-170	38	1F	169,34	166,60	183	135		187	202		172	ocel	
40-14M-170	40	1F	178,25	175,49	188	140		187	202		162	ocel	
*44-14M-170	44	1F	196,08	193,28	211	160		187	202		175	ocel	
*48-14M-170	48	1F	231,90	211,11	226	160		187	202		180	ocel	
*56-14M-170	56	1F	249,55	246,76	256	160		187	202		182	ocel	
*64-14M-170	64	1F	285,21	282,41	296	180		187	202		184	ocel	
*72-14M-170	72	7	320,86	318,06		180	278	187	187	32		litina	
80-14M-170	80	7	356,51	353,71		180	314	187	187	32		litina	
90-14M-170	90	5	401,07	398,28		180	358	187	187	38		litina	
112-14M-170	112	5	499,11	496,32		200	456	187	187	38		litina	
144-14M-170	144	5	641,71	638,92		220	600	187	187	38		litina	
168-14M-170	168	5	748,66	745,87		220	706	187	187	38		litina	
*192-14M-170	192	5	855,62	852,82		220	813	187	187	38		litina	
*216-14M-170	216	5	962,57	959,76		220	920	187	187	38		litina	

* Na poptávku

* *Hodnoty se mohou lišit.